

EN & ENL SERIES - EN480-2

Endurance VRLA Batteries

Suitable for all standby applications including Telecommunications, UPS, Emergency Lighting. Endurance range Batteries from Yuasa are the engineer's choice for even the most critical standby applications, available in 10 year (EN) and 15 year (ENL) models.

FEATURES

- Long Life in standby (10 and 15 year design life options).
- Unique mix and match parallel assembly allows extensive variations to network capacity.
- Electrolyte Suspension. A.G.M. technology assures no free electrolyte to spill or worry about.
- High gas recombination efficiency. Eliminates the need for forced ventilation and separate battery rooms.
- Case Material Oxygen index 30.
- Fully compliant with BS6290-4 and IEC896-2.



General Specifications

Nominal Capacity (Ah)	EN480-2
10hr to 1.85vpc	480
3hr to 1.80vpc	387
1 hr to 1.75vpc	315
Voltage	2
Energy Density (Wh/L)	63
Specific Energy (Wh. kg)	27
Int Resistance (m.ohms)	0.2
Maximum discharge (A)	2880
Short Circuit current	4500
Dimensions (mm)	
Length	305
Width	210
Height overall (Inc. Lid)	240
Weight (kg)	35
Terminal	Female Insert
Terminal Torque (Nm)	6.1

Terminal

8mm Stud or Female Internal Thread

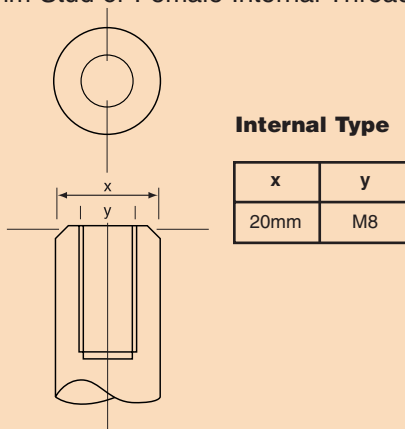

Layout

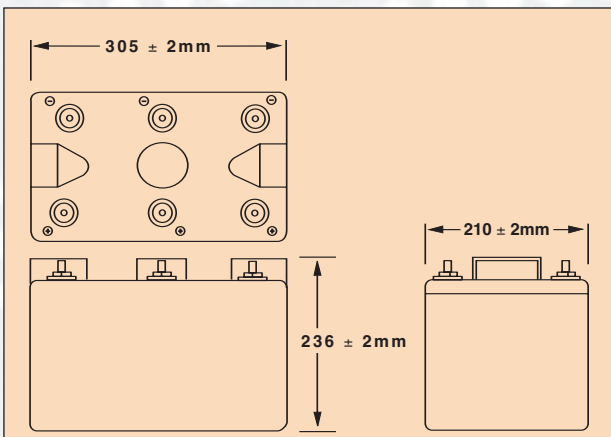

STANDBY FLOAT CHARGE DESIGN LIFE

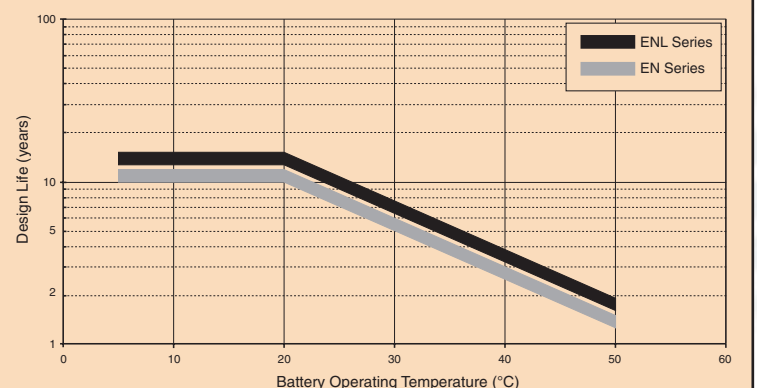

CHARGING CHARACTERISTICS

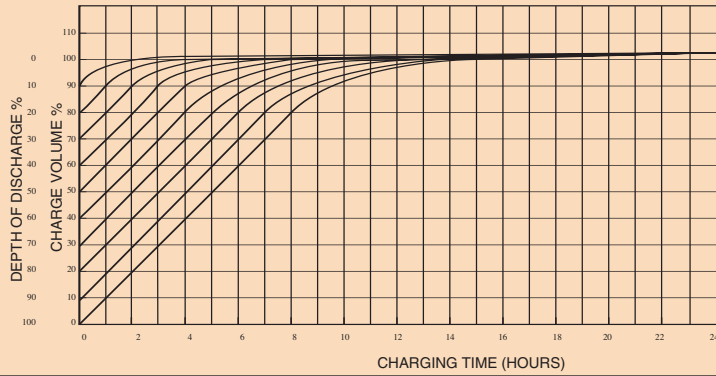

SELF DISCHARGE CHARACTERISTICS

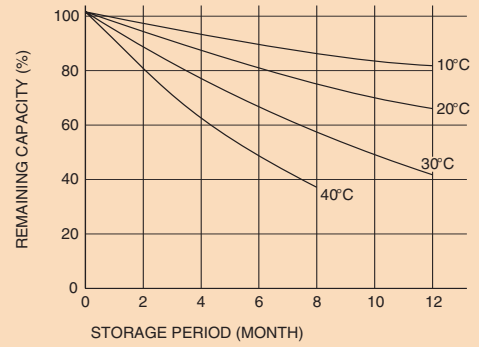

DISCHARGE CHARACTERISTIC CURVES

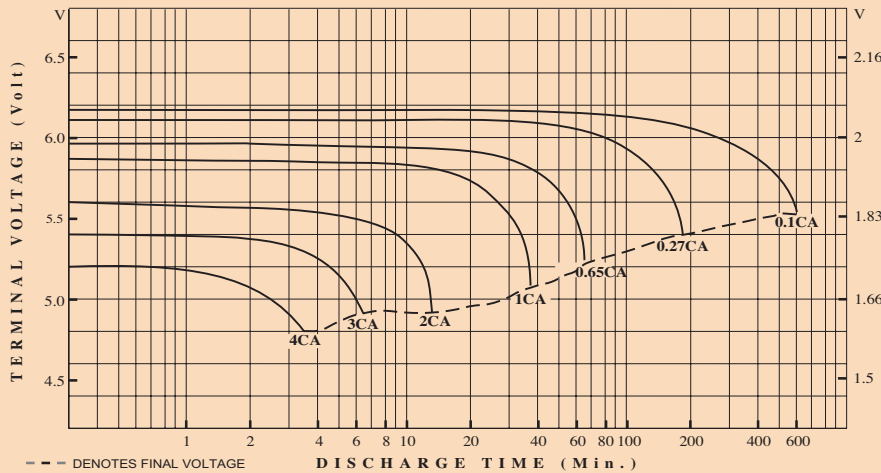

CHARGING CHARACTERISTIC

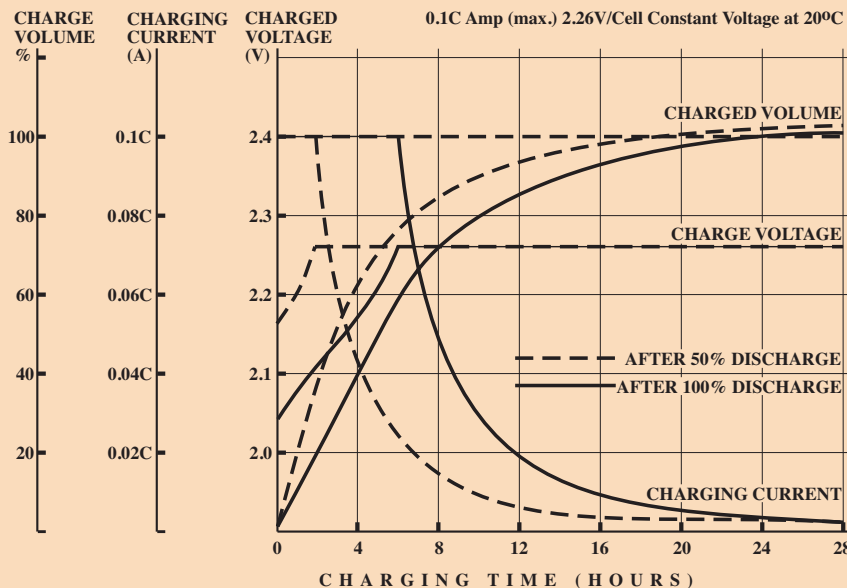

Charging Methods (at 20°C)

Standby use: Float charging voltage
2.26v ± 0.005v

CAUTION

- Avoid short circuit.
- Do not charge in a sealed container.



Yuasa Battery Sales (UK) Ltd

Unit 22 Rassau Industrial Estate
Ebbw Vale, Gwent, NP23 5SD
Tel: 08708 500312 Fax: 08708 500317
E-mail: enquiries@yuasa-sales.co.uk

Registered number 1548820

Cat. No. EN480-2 February 07

E&O.E.

Distributed by